

Smart lock



user manual

 **ATTENTION:**

The lock comes with “English” voice as standard, and you can switch to other language by the following operations

 **keep the lock under factory default without any users registered**

Activate the keypad and input the code for other language of the voice

333666990  - French

333666991  - English

333666992  - Arabic

333666993  - Russian

333666994  - Portuguese

333666995  - Thai

333666996  - Spanish

333666997  - Vietnamese

333666998  - Indonesian

Installation guide

1. Accessory

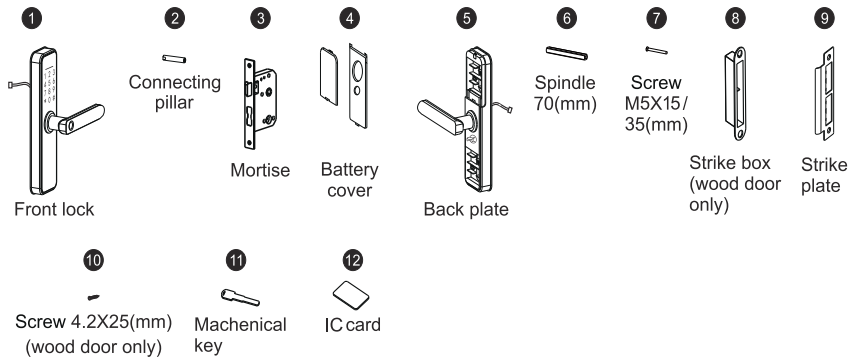

2. Door opening direction

① Right handle opening

② Left handle opening

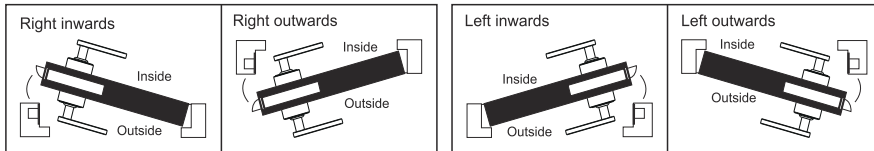

3. Shift the left and right

According to your needs to adjust the left and right by a screw driver to release screw, then turn the handle 180 degree, then fix the screw.

Note: Do not unscrew the screw in the handle hole, if there is broken when you do that, you will not have any warranty.

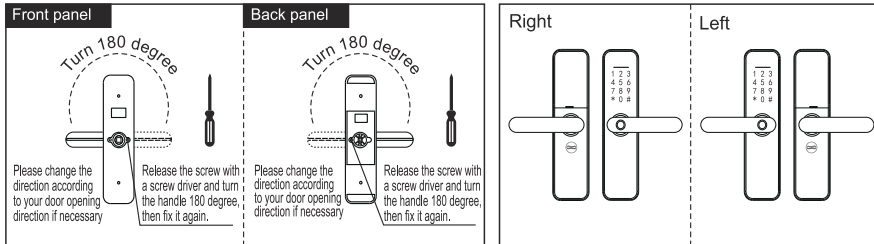

4. Adjust the mortise direction

According to your need to adjust the mortise direction.

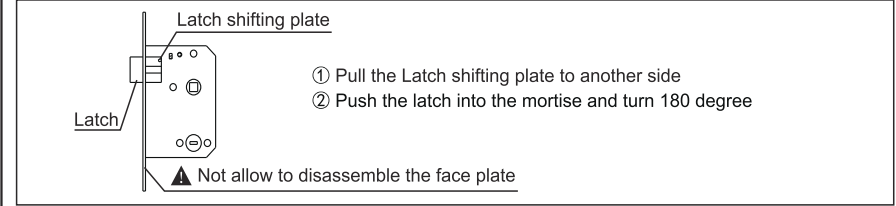

5. Accessories for sorts of door thickness

Available door thickness 32mm-55mm. If the door is over this range, please contact us for more information. Please select the correct accessories according to your door thickness.

Code and name	Specifications(mm)	door thickness ranges & QTY	
		32≤M≤40(mm)	41≤M≤55(mm)
⑥ Spindle 70(mm)		1	1
⑩ Screw M5*15(mm)		2	0
⑦ Screw M5X35(mm)		0	2
② Connecting pillar 30/35(mm)		2	2

6. Caution before installation

- Do not be a strong force when installation, avoid to damaging the lock.
- Use correct installation tools.
- Wear glass to protect your eyes when drilling holes.
- Drilling the door holes on both side of the door avoiding to damaging the door plate.

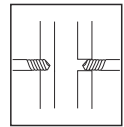
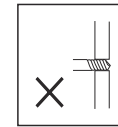
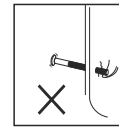

7. Installation

Installation steps:

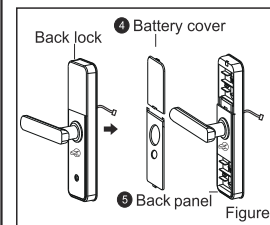

- (1) As Figure 1:
① Divide the Back Lock into Battery cover and Back panel.

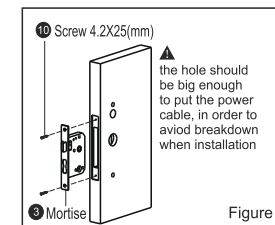

- (2) As Figure 2:
① Make the mortise cable get through the door plate, fix the mortise with 2 screws.

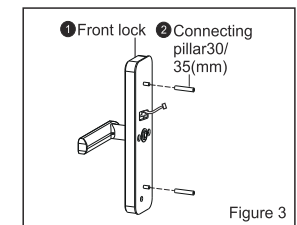

- (3) As Figure 3:
① Fix the two connecting pillars on the front panel

7. Installation

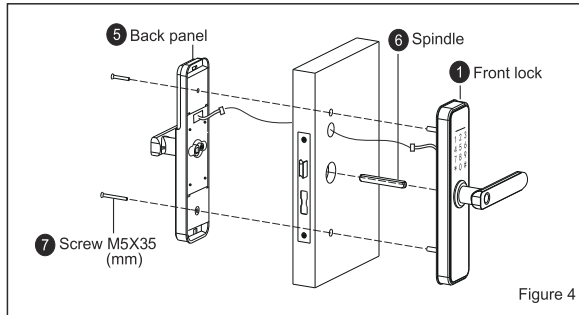

Figure 4

(4) As Figure 4:

- ① Put the spindle on the mortise.
- ② Make the front panel cable across to the door plate and connect to the back panel.
- ③ fix the front panel and back panel with two screws.

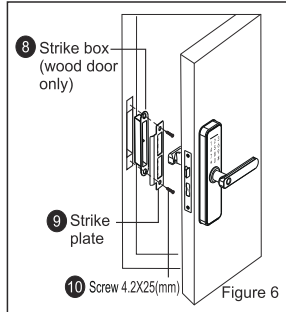

Figure 6

(6) As Figure 6:

- ① Install the strike box and strike plate on the door frame with 2 screws.
(Note: this no strike box for steel door frame)
- ② Test the lock if it works correctly.

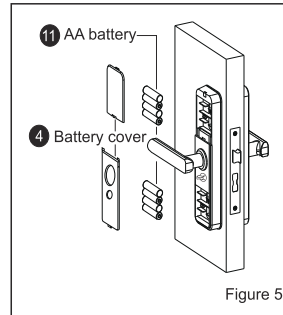

Figure 5

(5) As Figure 5:

- ① Put the Batteries correctly and fix the Battery cover.

8. Check points after installation

- ① The face plate is horizontal with the door.
- ② The Latch bolt, Dead bolt and Security Bolt must works smoothly and flexibly.
- ③ The Front lock is vertical and stable.

Smart lock operation manual

1.Function and Operation

1.1 Description of terms and functional keys

- 1) Administrator information: refer to the Administrator's fingerprint, password or IC card.
Unlock information: refer to the input fingerprint, password ,Remote control or IC card information (including Administrator and ordinary users).
- 2) Key"*": clear key/back key. Enter the password or point by clearing the previous input. Press the clear key three times in succession, empty all input.
- 3) Key"☰": confirmation key or menu function key.

2. Original state

- 1) The factory administrator orinital password is 123456, under the orinital state any fingerprint, IC card or password can open the lock.
- 2) Any fingerprint, IC card ,or password which are not registered can't open the lock after inputting the administrator information.

3. Lock function management (step one)

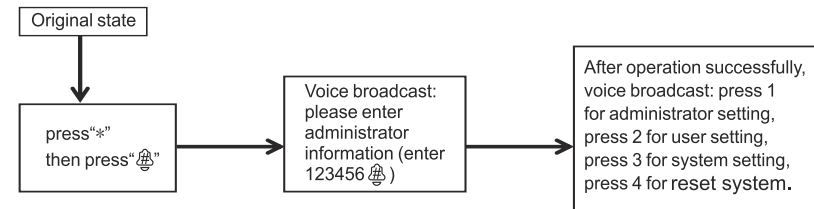

4. Administrator settings

1) Add administrator (step 2)

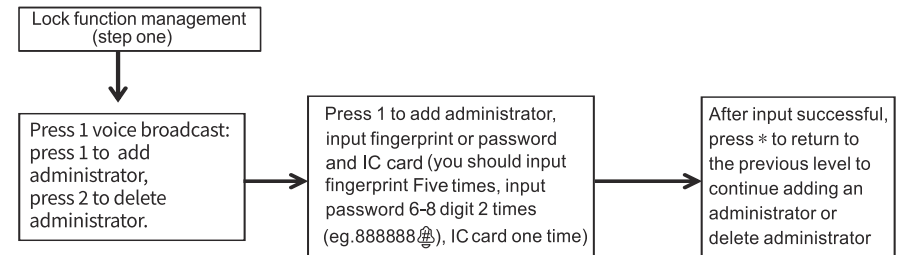

2) Delete administrator information

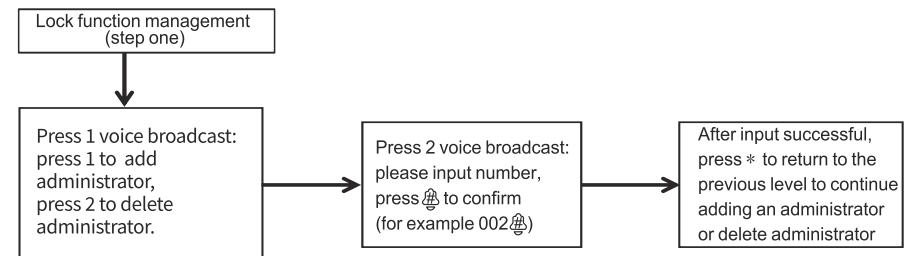

5. Common user setting

1) Add user information

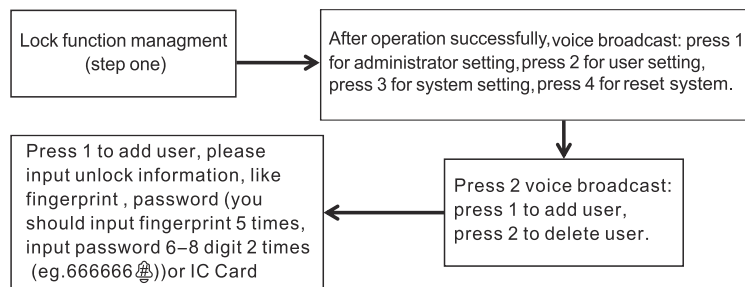

2) Delete user information

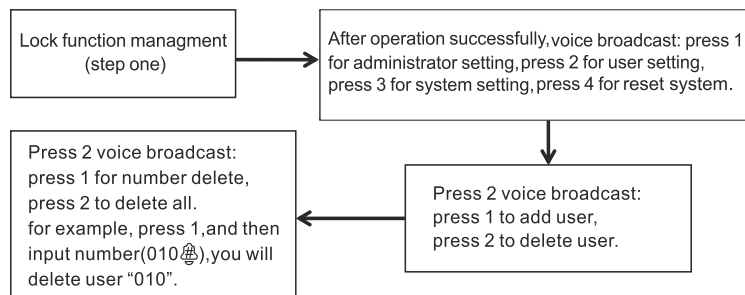

6. system setting

1) Voice setting

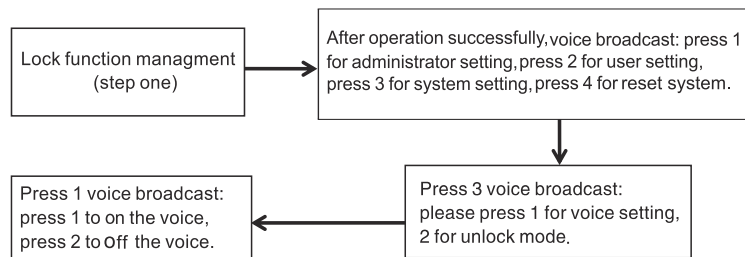

2) Unlock mode setting

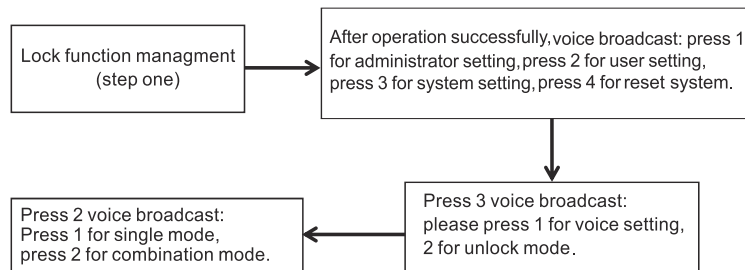

7. Restore factory settings

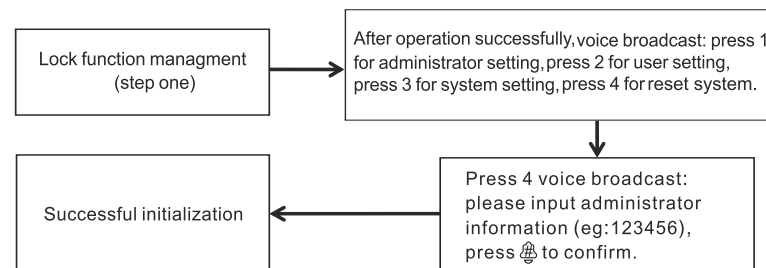

8. APP Configuration (Tuya Smart) - optional

- 1) Search "Tuya Smart" in App Store or an App market, or scan the QR code download and install it.



- 2) Register with your cell phone number and log in.
- 3) Click on "Security & Sensor," then find "Lock (Wi-Fi)" and proceed to add a device by following the steps below.
- 4) Press "*" + "5" to authenticate the administrator's identity, and then press "1" to access the administrator settings. Following this, a voice prompt will guide you to press "3" for network configuration.
- 5) Press "3" for the network configuration mode. The voice prompt will instruct you to press "1" for hotspot connection and "2" for intelligent connection.
- 6) Choose "2" and wait for the network to be successfully added.



Important Notes:

1. Please ensure the administrator is added before proceeding with the settings.
2. Make sure the lock is near the router during the connection process.
3. If the connection fails, consider using hotspot connection as described in step 5 & 6.
4. Upon successful network addition, the "5" on the keyboard will flicker rapidly with a voice prompt confirming the completion of the operation.
5. In case of a network addition failure, the "5" on the keyboard will not flicker slowly, and a voice prompt of "operation failed" will be heard upon timeout.

Operations:

1. Unlock remotely by waking up the screen and pressing "5". A voice prompt will ask for remote unlocking. You can also view the outdoor camera's photos through the app.
2. For model 630max, you can view both the outdoor camera photos and monitor the indoor space via the app.

9. Other notes

- 1) Input the wrong password more than 5 times in a row, the keyboard locked for 30 seconds, it does not respond to any operations in 30 seconds.
- 2) Password peeping prevention function: input password as follows when opening the door with password: XXX password XXX; you can add some extraneous codes before and after the password, and then press  to confirm. The password must be included in the input contents.
- 3) If there is no operation more than 15 seconds, system will automatically exit.
- 4) After the voltage is lower than 4.8v, the lock will automatically alarm every time when it is opened. After the alarm, the lock can be opened for about 200 times.
- 5) Remove the battery cover, press the "Set" key for 6 seconds, Press  the lock was restored to factory mode;
- 6) When unlocking, input "5" to enter passage mode (One time effective);
- 7) When unlocking, input "*" to broadcast the user number;
- 8) When Electronic dead lock was opened, Only the administrator can open the lock

11. Technical Parameters

Technical Parameters			
	Items	Parameters	Memo
1	Static current	20-25uA	
2	Dynamic current	220mA	
3	Administrators number	9	
4	Fingerprint number	100	
5	Fingerprint + password + card capacity	512	
6	Fingerprint Sensor	Semiconductor	
7	Fingerprint contrast time	≅ 0.6Second	
8	Fingerprint identification Angle	360°	
9	False Rejection Rate	≅ 0.1%	
10	False Recognition Rate	≅ 0.0001%	
11	Reaction time	≅ 0.1 Second	
12	Power type	8V	
13	Emergency power	5VDC	
14	Working temperature	-25℃~60℃	
15	Working Relative Humidity	10%~90%RH	
16	Human voice	Yes	
17	Keyboard	Touch standard 12-bit keyboard	
18	Password Length	6-8 digits	
19	Phantom password	31 digits	
20	Low voltage alarm	4.6±0.2V	
21	Unlock time	≅ 1Second	
22	Camera	100W	
23	Lens angle	100°~140°	
24	Video	M-JPEG encoding, 15frames/s	
25	Resolution	1280*720	